



BIG REACH, BIGGER PERFORMANCE

Big reach, big performance. The Astra 3 Double Arm was designed to provide outstanding reach in a small footprint. With nearly 3 feet of extension from the base and a 270° rotating head, the Astra 3 Double Arm puts illumination exactly where it is needed. Clustered, high-output, high CRI LEDs provide a crisp white light with no shadowing effect in a smaller footprint. The Astra 3 features programmable touch button controls, allowing the user to return to the same dimming level as last used, double touch to maximum brightness and programming for auto shut-off after 5 or 10 hours of use. Astra 3 also includes an energy saving Occupancy Sensor that turns on the Astra 3 with movement and turns off after 15 minutes of inactivity.



Touch button design with auto shut-off programming and brightness memory.



Energy saving Occupancy Sensor turns on with movement and off after 15 minutes of inactivity.

ASTRA 3 DOUBLE ARM LED DESK LIGHT

Specifications:

- 34.9" Reach from base/mount
- Multiple base options
- Bright white light output: 3100K, 93 CRI
- Included occupancy sensor
- Continuous dimming from 100% – 5%
- Touch button on/off & dimming controls
- UL Certified, Energy Star Compliant Luminaires V1.2
- 50,000+ hour life LED's (L70 rating)
- 5 year fixture warranty
- Available in silver
- 12 W transformer included:
 - 24 V, 0.5 A, Class 2 transformer: 3" x 1.125" x 1.75"
 - Two prong plug on 6 foot cord, connects to 3 foot cord attached to fixture

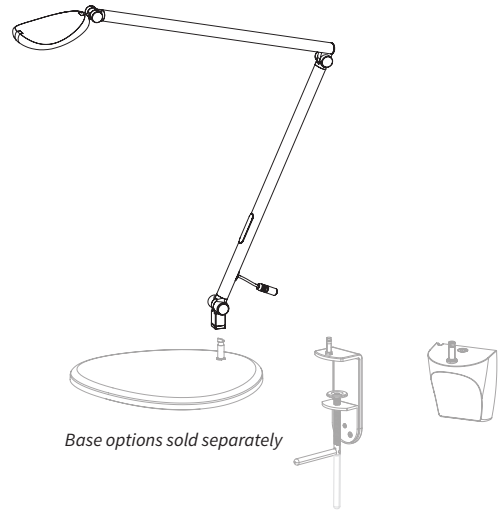

Dimensions

Horizontal and vertical reach

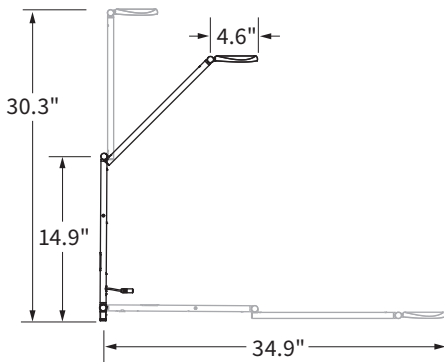

Fixture pivot & rotation

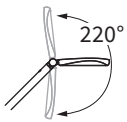

Shade pivot

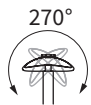

Shade rotation

Photometrics

Source at 15"

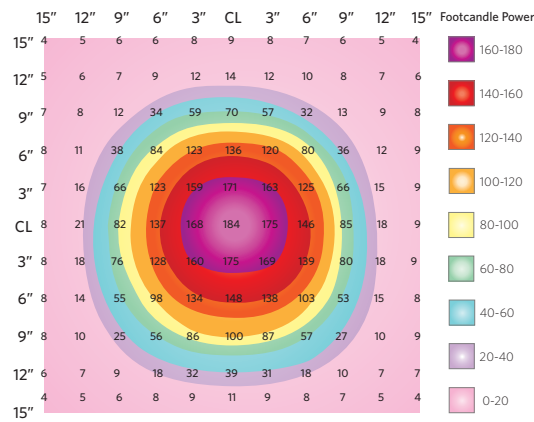

Occupancy Sensor

Height & width

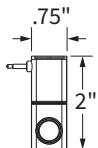

Range & field of view

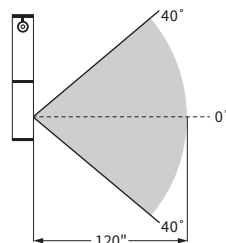
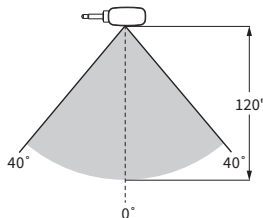

ASTRA 3 DOUBLE ARM LED DESK LIGHT

Double Arm Luminaire

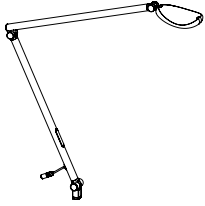

- Foot candle power (@ 15"): **157 fc**
- Light output (lumens): **384 lm**
- Power consumption (wattage): **5.7 W**
- Lumens per watt: **67 lm/W**
- Photometric performance: **See chart on previous page**
- Light color temperature (CCT): **3100 K**
- Color Rendering Index (CRI): **93 CRI**
- Includes energy saving Occupancy Sensor

Model #	Weight	US \$ List	CAN \$ List
AST3-DA-WOB-S	2	\$246	\$315

Base Options

Table Base

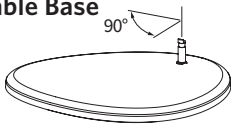

- Sturdy yet movable, this 4 pound table base lets you put your light exactly where you want it
- Provides 90° of rotation at the base
- Dimensions: 7"W x 7.5"D x .3"H

Model #	Weight	US \$ List	CAN \$ List
LTG-TB-TD-S	3	\$46	\$59

Two Piece C-Clamp Mount

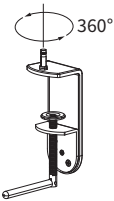

- The sturdiest and most compact mounting solution
- Two piece design provides easy installation in space constrained environments
- Provides 360° of rotation at the base
- Attaches to surfaces .25" – 2.5" thick
- Dimensions: 2"W x 1.75"D x 4.5" H

Model #	Weight	US \$ List	CAN \$ List
LTG-CCB-TP-S	1	\$23	\$29

Tool Bar, & Slatwall Mount

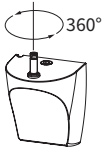

- Add some height to your light and conserve desk space by mounting to a Workrite Tool Bar
- Adjustable clamp design is also compatible with any 90° edge .5" – 1.75" Slatwall system.
- Provides 360° of rotation at the base
- Dimensions: 2.5"W x 2"D x 2.8"H

Model #	Weight	US \$ List	CAN \$ List
LTG-TSB-ADJ-S	1	\$36	\$46

